

Article number: 439500025  
 Description: Rota-fix shaft-hub connection F25x50  
 Steel  
 Note: Self centering. Very high torque

## Measures

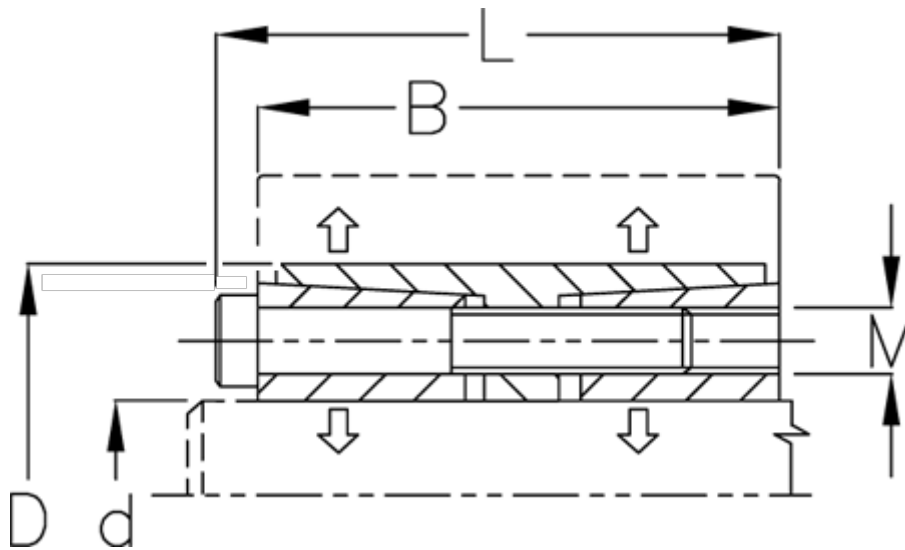

B mm	= 45
d H8 mm	= 25
D mm	= 50
Fit tolerance	= Aksel h8, Nav H8
F kN torque	= 55.0
L mm	= 51
M mm	= M6
P N/mm <sup>2</sup> surface pressure on shaft/hub	= 80

Surface roughness	= R? ? 3.2 µm
T N m torque	= 700
Ts N m bolt tightening torque	= 17.0